

CFW11 - System Drive

Variable Speed Drives

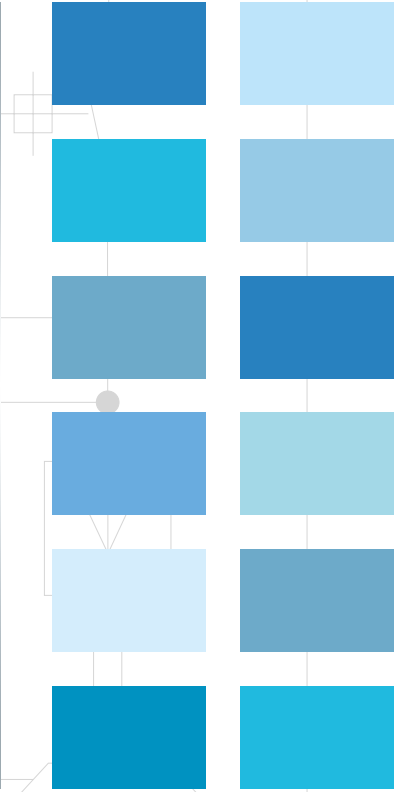
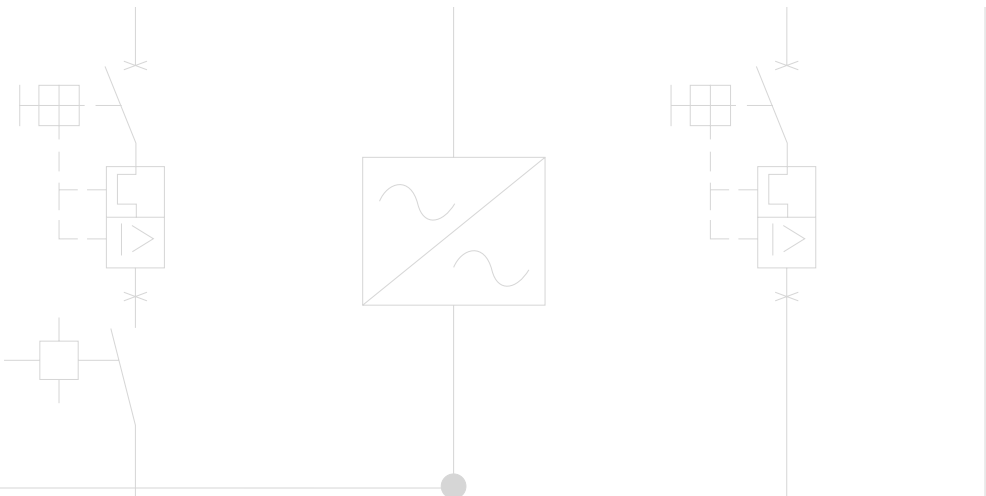

CFW11 - System Drive

The CFW11 is a system drive designed for the control of squirrel cage induction motors as well as permanent magnet motors. Since it was developed for running on Normal and Heavy Duty mode, a wide variety of applications can be achieved.

Designed for exclusively industrial or professional use, it provides increased productivity with excellent performance and quality improvement of the process in which it is used.

Innovative and User Friendly

The CFW11 presents many innovations that are helpful and beneficial to customers, mainly due to the simplicity of its installation and operation. The CFW11 was developed based on Plug & Play philosophy (connect and use) allowing simple and fast installation of the VSD and its accessories.

The Keypad has a navigation and programming system with soft-key buttons. It is possible to access the parameters sequentially or through groups of parameters. The Keypad also makes the Oriented Start-up function available, guiding the user through the necessary programming.

Flexibility

The CFW11 is adaptable to the customer's needs through a broad range of accessories which are easily installed. Besides that, the standard product comes with SoftPLC, allowing the customer to create his/her own user applications through the WLP software (Ladder programming).



1.1 to 2.2 kW - 1.5 to 3 HP
200-240 V ac - Single-phase

1.1 to 55 kW - 1.5 to 75 HP
200-240 V ac - Three-phase

1.5 to 2,000 kW - 2 to 2,500 HP
380-480 V ac - Three-phase

1.5 to 2,000 kW - 2 to 2,500 HP
500-600 V ac - Three-phase

1.5 to 2,000 kW - 3 to 2,500 HP
660-690 V ac - Three-phase

Certifications



Own Technology

Vectrue Technology®

- Linear and adjustable V/F, VVW (Voltage Vector WEG) and vector control are available on CFW11
- Two types of vector control: sensorless and closed loop vector control (encoder Interface required)
- Sensorless vector control permits high torque and quick response in open loop, even at low speeds
- The self-tuning function sets the vector control or VVW with the motor and to application load used
- By the adjustable V/F control, it is possible, for example, to adjust a quadratic V/F curve, providing energy savings for quadratic torque loads (e.g.: centrifugal pumps and fans)

Optimal Braking®

Applications involving high inertia loads, when applied short time deceleration, a large amount of energy returns from the motor to the VSD. To handle this energy, regular VSDs have to dissipate it as heat in power resistors. Such resistors are usually large and some installation criteria must be considered due to their heat dissipation. As an alternative to the use of braking resistors, CFW11 features a special braking method in vector control mode known as Optimal Braking®. This innovation delivers a high performance braking torque without requiring a braking resistor. The following graph shows the advantages of using Optimal Braking® compared to other braking methods, thus ensuring an optimized and low cost solution for braking applications.

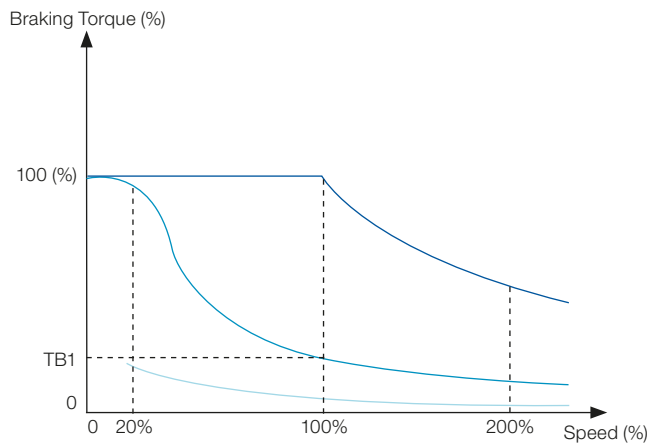

Typical Braking Torque x Speed Graph for a 10 HP / 7.5 kW motor driven by a CFW11

- Dynamic Braking Torque Curve
- Optimal Braking® Torque Curve
- DC Braking Torque Curve



WMagnet Drive System®

Variable Speed Drive controlling permanent magnet motors. The WMagnet System (WMagnet motor + CFW11) has the highest efficiency levels in the market. It is a perfect match for applications where speed variation, low noise level and reduced size are required. In Sensorless mode the WMagnet System is able to perform torque control at zero speed without the need of forced ventilation.

Main Characteristics of the Set CFW11 + WMagnet Motor

- Voltage range: 380 to 480 V ac
- Power rating: 11 to 160 kW (15 to 220 HP)
- Methods of control: sensorless vector and closed loop control (vector with encoder)
- WMagnet control algorithm included on the CFW11 standard version
- Communications protocols: Modbus-RTU, Modbus-TCP, Profibus-DP-V1, DeviceNet, CANopen Ethernet / IP, Profinet-IO and BACnet



Optimal Flux®

Technology for motors driven by VSDs in applications with constant torque loads:

- Rated torque at low speeds eliminating the necessity for forced ventilation or motor oversizing
- Space and cost reduction of the application
- Improved performance of the VSD and motor package (an exclusive WEG solution)

The Optimal flux function works when the set: high efficiency WEG motor + CFW11 is used.

Technical Features

Built-In DC Link Reactor

- Allows the VSD to be installed in any network (there is no minimum impedance restriction)
- Typical power factor (PF) for rated condition:
 - 0.94 for models with three-phase supply
 - 0.70 for models with single-phase
 - 0.70 for models with single-phase supply/three-phase supply = 0.94
- Displacement power factor > 0.98
- Meets the 61000-3-12 standard, related to low order current harmonics in the network
- Available until frame size G, for the frame size H is mandatory use external line reactor

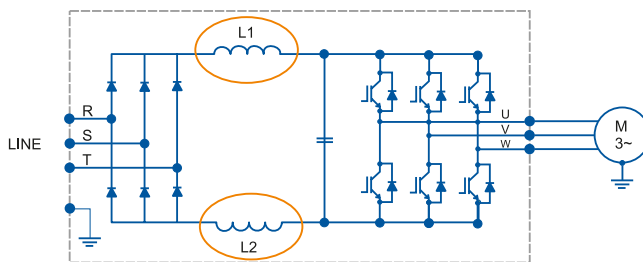

Note: no need for external line reactor, up to frame size G.

Conformal Coating

A special varnish is applied on the electronic boards of the CFW11, extending its lifespan, protecting against dust, humidity, high temperatures and chemical substances. Classified as 3C2 according to IEC 60721-3-3. Standard for the complete line.

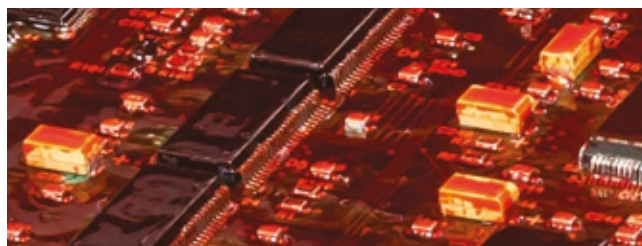

Single DC Busbar

Usually used in multi-motor systems, common DC bus configuration is a good solution for energy savings. In this configuration, individual VSD rectifier bridges are replaced with a common input rectifier unit. Each VSD is then directly fed from the DC bus to its DC link terminals.

This solution allows the energy in the DC bus to be shared among the VSDs connected to it, thus optimizing the power consumption in the system.

The standard CFW11 sizes A to E and special hardware version (DC) for frame sizes F, G and H can be connected to a DC bus system. (When required, the factory can be consulted for further details)

Note: an extra pre-charge circuit must be added to each of the VSDs.

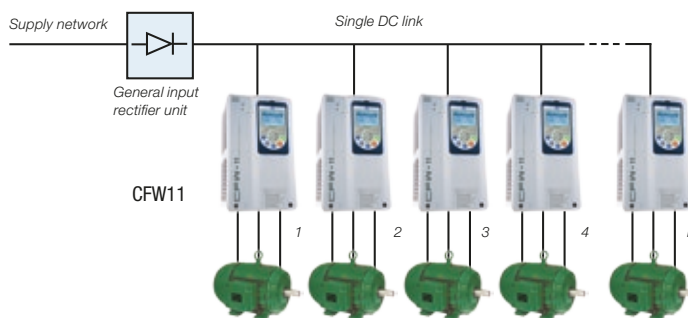

Intelligent Thermal Management

- Monitoring of the heatsink and internal air temperatures of the electronic boards, providing total protection of the IGBTs and the CFW11 as a whole
- The heatsink fan is turned on and off automatically, depending on the temperature of the power modules
- The speed and the fan's operation hours number are monitored and indicated in corresponding parameters. Alarm or fault messages are generated related to these variables
- The fan can be easily removed for cleaning or replacement



Flexibility is Our Philosophy

The CFW11 was developed based on Plug & Play philosophy, identifying automatically the accessories plugged in, as well as easy installation and safe operation with no need for extra configuration.

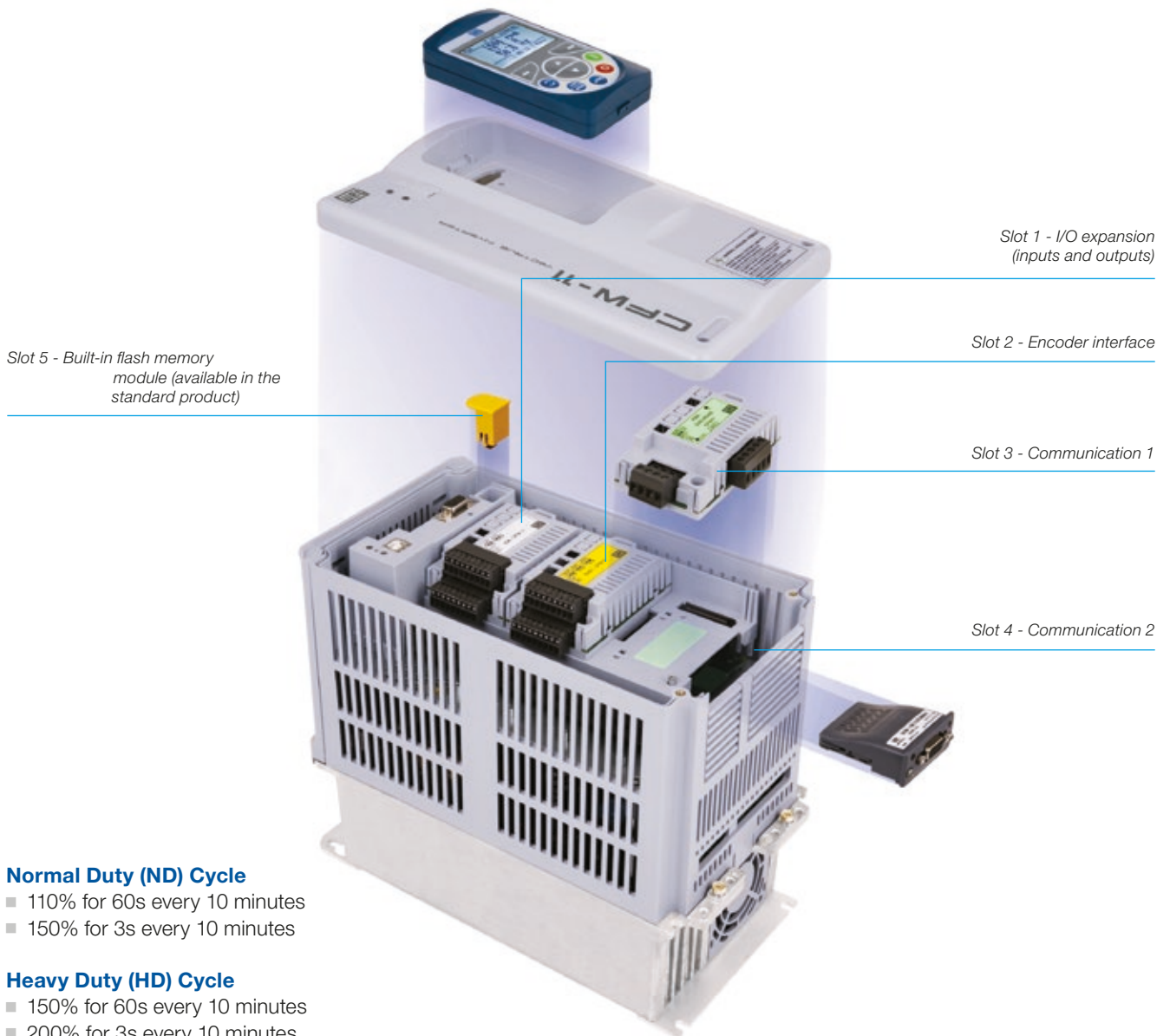

Normal Duty (ND) Cycle

- 110% for 60s every 10 minutes
- 150% for 3s every 10 minutes

Heavy Duty (HD) Cycle

- 150% for 60s every 10 minutes
- 200% for 3s every 10 minutes

Functions

- **Multi-speed:** up to 8 pre-programmed speeds
- **PID regulator:** automatic control of level, pressure, flow, weight, etc.
- **Ride-through:** operation during momentary loss of the power supply
- **Skip frequency:** rejection of critical or resonant speeds
- **S ramp:** smooth acceleration / deceleration

- Braking IGBT (chopper) can be offered built-in or with external module (DBW03/DBW04)
- Encoder module can do the interface between the Drive and Motor, promoting the closed-loop speed and position control
- Temperature monitoring of motor probes (PTC, Pt-100, KTY84), providing thermal protection to the motor (accessory is necessary)
- Operating air temperature up to 60 °C (140 °F) for sizes A to D, and up to 55 °C (131 °F) for size E, F, G and H with derating (check page 26)
- Motor overload protection according to IEC 60497-4-2 and UL 508 C

Applications

The CFW11 can be used in both simple or sophisticated applications, due to its broad range of functions and easy configuration, installation and operation. The CFW11, through its vectrue inverter technology, presents excellent static and dynamic performance, precise torque and speed control, dynamic response, positioning accuracy, and high overload capacity. The CFW11 was also developed for applications where the decisive factor is safety, by several built-in protections and alarms as well as through the safety stop function in accordance with EN ISO 13849-1 and IEC 62061 / IEC 61508.



Cement and Mining

- Robust and large overload capacity (models sized in HD)
- Provided in a compact design the CFW11 Series allows the assembly directly next to one another with no derating
- Possibility to be integrated in a variety of communication protocols commonly used in industry
- Quick and simplified programming
- Highly reliable and robust
- For large power ratings, modular topology is used



Pumps and Fans

- Precise control of process variables (pressure, flow, temperature, etc.) through a PID regulator superposed to the speed control
- Optimization of power consumption through speed control with an adjustable V/F curve
- Possibility of safety and maintenance signalling, and alarms of pumps and fans
- Availability of PID regulators to control other process accessories like valves, dumpers, other VSDs, etc.



Compressors

- Optimization of system pressurization control with energy savings and improvement of compressor efficiency
- Reduction of motor startup current, minimizing wear and tear of the mechanical system, avoiding fees charged by the power supplier company
- Possibility of safety and maintenance signaling and alarms of pressurization system
- Provides startup system control of other compressor units with an increased efficiency of the pressurization system



Sugar and Alcohol

- Modular and compact
- 12-pulse rectifier for reduction of harmonic content
- Regenerative braking for centrifuges
- Highly robust and reliable



OverHead Cranes / Lifting

- SoftPLC function
- Three modes of vector control
- Highly compact
- Intelligent control of ventilation system



Process Machines

- Built-in PLC and real time clock
- Easiness and flexibility for connecting to the most used fieldbus network
- Fieldbus
- Precise speed and torque in all speed ranges
- User friendly interface and programming

Applications



Paper and Cellulose / Wood

- Four monitoring parameters displayed at once on the keypad
- USB communication port at the front of the VSD for data monitoring and parameters configuration via software SuperDrive
- Precise speed and torque control
- Flexible hardware programming and configuration, making applications where synchronism is required easier
- Possibility to be integrated in a variety of communication protocols commonly used in industry
- Provided in a compact design the CFW11 Series allows the assembly directly next to one another with no derating
- Quick and simplified programming
- Highly reliable and robust
- For large power ratings, modular topology can be used



Ironworks and Metallurgy

- Highly precise speed and torque control
- Large overload capacity (models sized in HD)
- Flexible hardware programming and configuration
- Possibility to be integrated in a variety of communication protocols mainly used in the industry
- Provided in a compact design the CFW11 series allows the assembly directly next to one another with no derating
- For large power ratings, modular topology is used

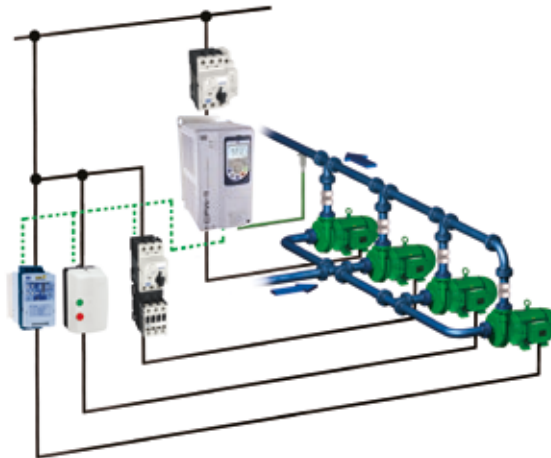

Multi-Pump Control

The CFW11 features the Multipump Control, which permits the CFW11 to control up to 5 pumps in order to keep constant pressure regardless of the flow fluctuations. In this system, an intelligent algorithm control of pumps provided by means of a user application developed to run on CFW11 decides when to start or stop each pump based on the system demand. Besides that, the VSD also monitors the suction pressure and the tank level. The CFW11 also alternates the pumps according to their operating time, thus ensuring an uniform wear and tear of

motors and pumps. Two types of Multipump Control are available: fixed and floating controls. In fixed control, the VSD is able to control one of the pumps at variable speed and to start and stop other 4 pumps at fixed speed. In floating control, the VSD is able to control up to 4 pumps, all of them at variable speed. The Multipump Control for CFW11 is available as an user application on SoftPLC (see page 16) and can be downloaded at www.weg.net.



Chemical and Petrochemical

- Highly reliable and robust
- Provided in a compact design the CFW11 Series allows the assembly directly next to one another with no derating
- Plug & Play system for additional modules, ensuring greater flexibility in adapting to existing systems
- Possibility to be integrated in a variety of communication protocols commonly used in the industry

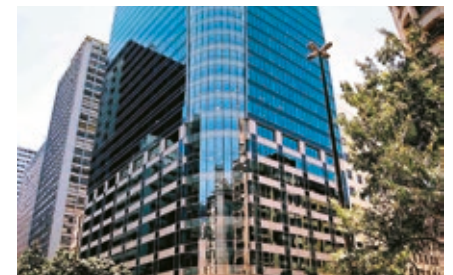

Cooling

- SoftPLC function built in the standard product enabling the use of two controllers simultaneously. This characteristic is for HVAC applications
- Three monitoring parameters displayed at once on the keypad
- USB communication port at the front of the VSD for data monitoring and parameters configuration via software SuperDrive G2

Intuitive

The CFW11 keypad was developed for simple and fast interaction while providing excellent visibility for the user.

Easy to Use Interface Tools

- Graphic display
- Soft-keys for easy operation
- Backlight
- Real time clock
- Copy function
- Plug-in (connection with CFW11 turned on)
- Language selection
- Remote keypad



Left soft-key: function defined by the display

Right soft-key: function defined by the display

Keys for scrolling through menus and parameters and for modifying parameter content

FWD/REV selection key

Start key

Local / Remote selection key

Stop key

JOG key



Remote Keypad

The keypad can be installed on panel doors or machine consoles with a IP56 protection degree.

Human Machine Interface

The keypad can be configured to display reading parameters in three different modes.

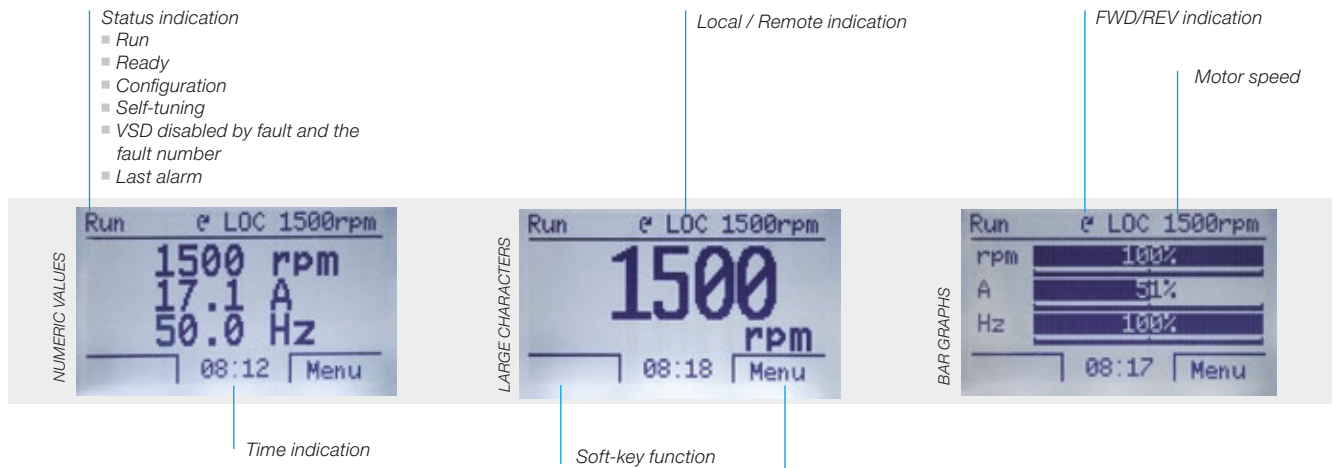

The keypad displays parameters in a hierarchy mode organized by groups.

Oriented Start-Up

For simplified Start-up, the CFW11 guides the user through the necessary programming to adjust the VSD to the motor and power supply.

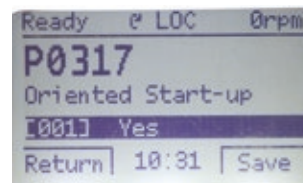

Basic Application

The Basic Application Group contains the basic parameters, which need to be adjusted in most applications. The CFW11 guides the user through these parameters.

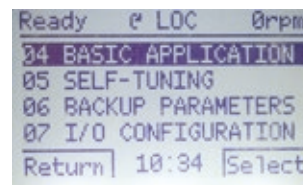

Fault History Group

It shows the parameters with the last 10 faults and the day, month, year and time when they occurred.

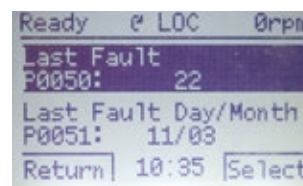

Read Only Parameters Group

It shows reading parameters only.

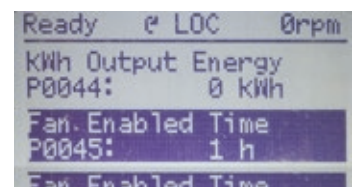
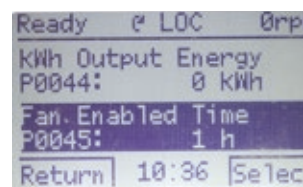

Backup Parameters Group

The Backup Parameters Group allows CFW11 parameters to be transferred to the Keypad or FLASH memory module (available in the standard product) and vice versa. During CFW11 operation, the modified parameters are saved in the FLASH memory module automatically.

Functions Group

The keypad offers the functionality of displaying parameter groups in individual folders where each of them shows specific configurations. For example: I/O configuration, self-tuning procedure, basic parameters, etc.

Selectable Language

The user can choose the keypad language: Portuguese, English, Spanish, German, French.

Changed Parameters Group

It shows only the parameters that have been programmed differently from the factory default.

Accessories

	Name	Description	Slot	Appearance
I/O expansion	IOA-01	1 14-bit analog input in voltage or current 2 digital inputs 2 14-bit analog outputs in voltage or current 2 open collector digital outputs	1	
	IOB-01	2 isolated 12-bit analog inputs 2 digital inputs 2 isolated 11-bit analog outputs in voltage or current 2 open collector digital outputs	1	
	IOC-01	8 digital inputs 4 digital outputs (use with SoftPLC)	1	
	IOC-02	8 digital inputs 8 open collector digital outputs (use with SoftPLC)	1	
	IOC-03	8 digital inputs 7 open collector digital outputs External 24 V dc (use with SoftPLC)	1	
Temperature transducers	IOE-01	5 PTC type temperature sensor inputs	1	
	IOE-02	5 Pt-100 type temperature sensor inputs	1	
	IOE-03	5 KTY84 type temperature sensor inputs	1	
Interface with encoder	ENC-01	Incremental encoder module 5 to 12 V dc (internal power supply) 100 kHz With encoder signal repeater (external power supply needed)	2	
	ENC-02	Incremental encoder module 5 to 12 V dc (internal power supply) 100 kHz	2	

Blank Cover - HMID - 01¹⁾

Blank cover to replace the standard VSD keypad, when it is not used.



Note: 1) This optional must be factory fitted and orders must specify on the product coding (page 17) the desired option.

Remote Keypad Frame - RHMIF-01

Frame for keypad installation on panel door or machine console.
IP56 protection degree.



Accessories

	Name	Description	Slot	Appearance
Communication	RS485-01	RS485 serial communication module (Modbus-RTU and BACnet)	3	
	RS232-01	RS232C serial communication module (Modbus-RTU)	3	
	CAN/RS485-01	CAN/RS485 interface module (CANopen, DeviceNet, Modbus-RTU and BACnet)	3	
	CAN-01	CAN interface module (CANopen and DeviceNet)	3	
	PROFIBUSDP-01	Profibus-DP-V1 interface module	3	
	EtherCAT	EtherCAT interface module	3	
	PROFIBUS-05	Profibus-DP-V1 module (Anybus-CC)	4	
	DeviceNet-05	DeviceNet module (Anybus-CC)	4	
	RS232-05	RS232 interface module (passive) (Modbus-RTU)	4	
	RS485-05	RS485 interface module (passive) (Modbus-RTU)	4	
	Modbus-TCP-05	RS485 Modbus-TCP interface module - 1 port	4	
		RS485 Modbus-TCP interface module - 2 ports	4	
	PROFINETIO-05	Profinet IO interface module (Anybus-CC)	4	
ETHERNET/IP-05	Ethernet/IP interface module - 1 port	4		
	Ethernet/IP interface module - 2 ports	4		
PLC functions	PLC11-01	Module with PLC functions (see page 14)	1, 2 and 3	
	PLC11-02	Module with PLC functions (see page 14)		

Accessories

Kit for Power Cable Shielding

CFW11 has a kit to simplify the connection of the motor cable shield to ground, providing a low-impedance connection for high frequencies.

Name	Description
PCSA-01	Kit for power cable shielding for frame size A
PCSB-01	Kit for power cable shielding for frame size B
PCSC-01	Kit for power cable shielding for frame size C
PCSD-01	Kit for power cable shielding for frame size D or 2D (IP54)
PCSE-01	Kit for power cable shielding for frame size E or 3 (IP54)
PCS1-01	Kit for power cable shielding for frame size 1 (IP54)
PCSC-02	Kit for power cable shielding for frame size 2C



Notes: 1) The kit for power cable shielding PCSD-01, PCSE-01 is provided along with VSDs having factory fitted RFI filter. Example: EU CFW11 0007 T 2 O FA Z.
 2) In frame sizes D and E the power cable shielding kit is factory standard, even for VSDs without internal RFI filter.
 3) N/A for frame sizes F, G and H.

Enclosures

Standards	Ratings	Frame sizes						
		A	B	C	D	E	F & G	H
IEC	IP20	-	-	-	X	X	X	X
	IP21	X	X	X	KIP21D-01	-	-	-
NEMA	TYPE 1	KN1A-01	KN1B-01	KN1C-01	X	KN1E-01 / KN1E-02	KN1F-01 / KN1G-01	-

Note: (X) Standard
 (-) N/A



Standard	Accessory	Composition
NEMA Type1	KN1A-01	Conduit kit frame size A
	KN1B-01	Conduit kit frame size B
	KN1C-01	Conduit kit frame size C
	KN1E-01	Top cover size E models 105 and 142
	KN1E-02	Top cover + Conduit kit size E models 180 and 211
	KN1F-01	Conduit kit for frame size F
IEC	KN1G-01	Conduit kit for frame size G
	KIP21A-01	Top cover kit frame size A
	KIP21B-01	Top cover kit frame size B
	KIP21C-01	Top cover kit frame size C
	KIP21D-01	Top cover kit frame size D

Note: in the KN1X-01 conduit kit (frame sizes A, B and C) power cable shielding is also provided.



Optionals

Safety Stop in Accordance with EN 61800-5-2, EN ISO 13849-1, IEC 62061, IEC 61508 Parts 1-7, EN 50178, IEC 60204-1, Cat. 3/PL d acc. and SIL CL2 acc.

With the activation of the safety stop function, the PWM pulses of the IGBTs are disabled. Since no torque is applied to the motor thus, it is ensured that the motor remains stopped providing system safety.



Note: this optional must be factory fitted and orders must specify on the product coding (page 17) the desired option.

External Control Supply in 24 V dc¹⁾

Used with communication networks (Profibus-DP, DeviceNet, EtherNet/IP, etc.) so that the control circuit and the interface for the communication network still working even removing the main (AC supply).



Note: 1) This optional must be factory fitted and orders must specify on the product coding (page 17) the desired option.

RFI Suppressor Filter¹⁾ (for the VSD to be in Accordance with EN 61800-3 and EN 55011)

CFW11 models with built-in RFI filter, when properly installed, meet the requirements of the electromagnetic compatibility directive – “EMC Directive 2004/108/EC”.

Example: EU CFW11 0007 T 2 O FA Z

For models from frame size A to D, the RFI filter is optional. But for models in frame size E, F, G, and H, the RFI filter is included in the standard product.



Note: 1) This optional must be factory fitted and orders must specify on the product coding (page 17) the desired option.

CFW11 - Dynamic Braking Module DBW03 and DBW04

DBW03 or DBW04 modules can be used when the application involves high inertia loads and requires fast deceleration, to dissipate the returning energy as heat and to keep the DC bus voltage within the limits.

These braking units were developed to allow drives from frame sizes F, G, H and Modular to be used with external resistors.



Braking module model		
Frame sizes F, G and Modular	DBW03 0380 D 3848SZ	DBW03 0250 D 5069SZ
Frame size H	DBW04 0380 D 3848SZ	DBW04 0250 D 5069SZ
Maximum output current	380 A	250 A
Minimum resistor	1.8 Ω	2.6 Ω
External power supply for fans	220 V ac +/- 5% @ 250 mA	

PLC11

PLC Accessories

PLC11 accessory provides the CFW11 with PLC functionality, speed reference generator and motion control functions. It comes in two options: PLC11-01 and PLC11-02 (see differences in the table below).

In many applications, these accessories allows the CFW11 to replace an external PLC, reducing application costs.

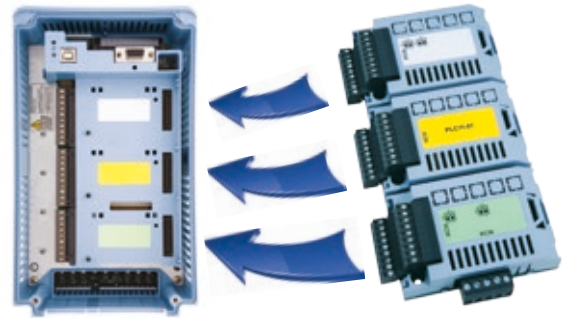

CFW11's PLC module installation

PLC11 module

Features

- Motion control with trapezoidal “S” profiles (absolute and relative)
- Machine initial position search (homing)
- Ladder programming through WLP software with timers, counters, coils and contacts
- RS485 serial interface with Modbus-RTU protocol
- 100 configurable parameters available to the user via keypad or WLP
- Master/Slave function (electronic gearbox)
- CAN interface for CANopen and DeviceNet protocols
- CANopen Master, which allows CFW11 to control up to 25 slave devices
- WLP/ WSCAN software: network configuration and programming software in the same environment

Technical Specification

Inputs/Outputs

- Digital inputs
- Digital outputs
- Relay outputs
- Encoder interface inputs
- RS485 interface
- CANopen interface
- Analog outputs
- Analog inputs

PLC11-01

- 9 bidirectional isolated inputs 24 V
- 3 bidirectional isolated open-collector outputs: 24 V dc, 500 mA
- 3 outputs NO contacts: 250 V ac, 3 A
- 2 incremental encoder inputs 5...12 V dc, 500 mA (internal power supply)
- 1 RS485 port (Modbus-RTU available)
- 1 CAN port (CANopen and DeviceNet available)
- 1 differential input: -10...+10 V dc / 0...20 mA, 14 bits
- 2 analog outputs: -10...+10 V dc / 0...20 mA, 12 bits

PLC11-02

- 4 bidirectional isolated inputs 24 V
- 3 bidirectional isolated open-collector outputs: 24 V dc, 500 mA
- 1 outputs NO contacts: 250 V ac, 3 A
- 2 incremental encoder inputs 5...12 V dc, 500 mA (internal power supply)
- 1 RS485 port (Modbus-RTU available)
- 1 CAN port (CANopen and DeviceNet available)

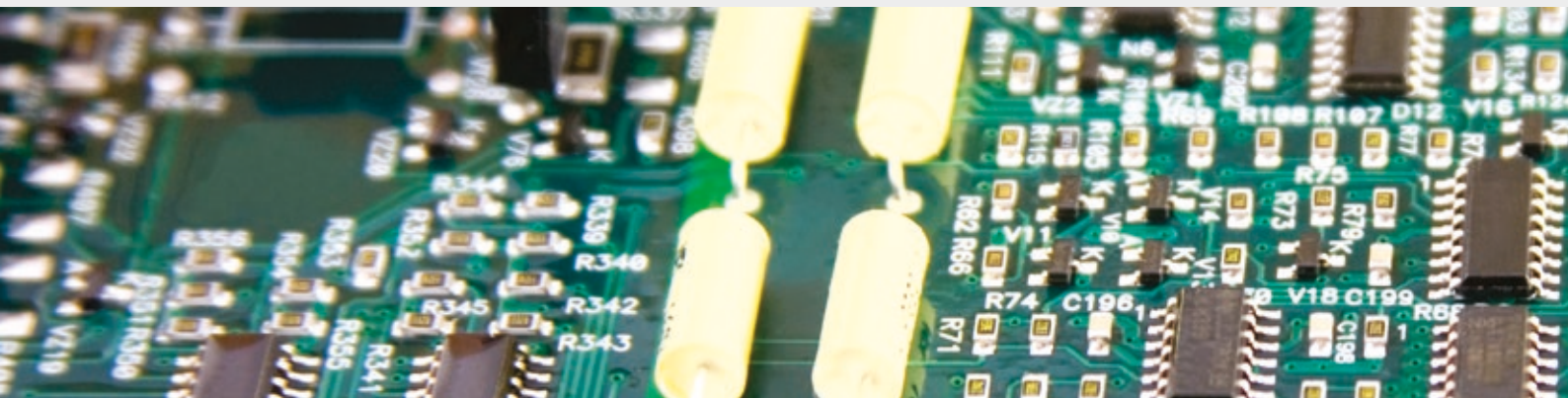

PLC11

PLC11-01 as CANopen Network Master

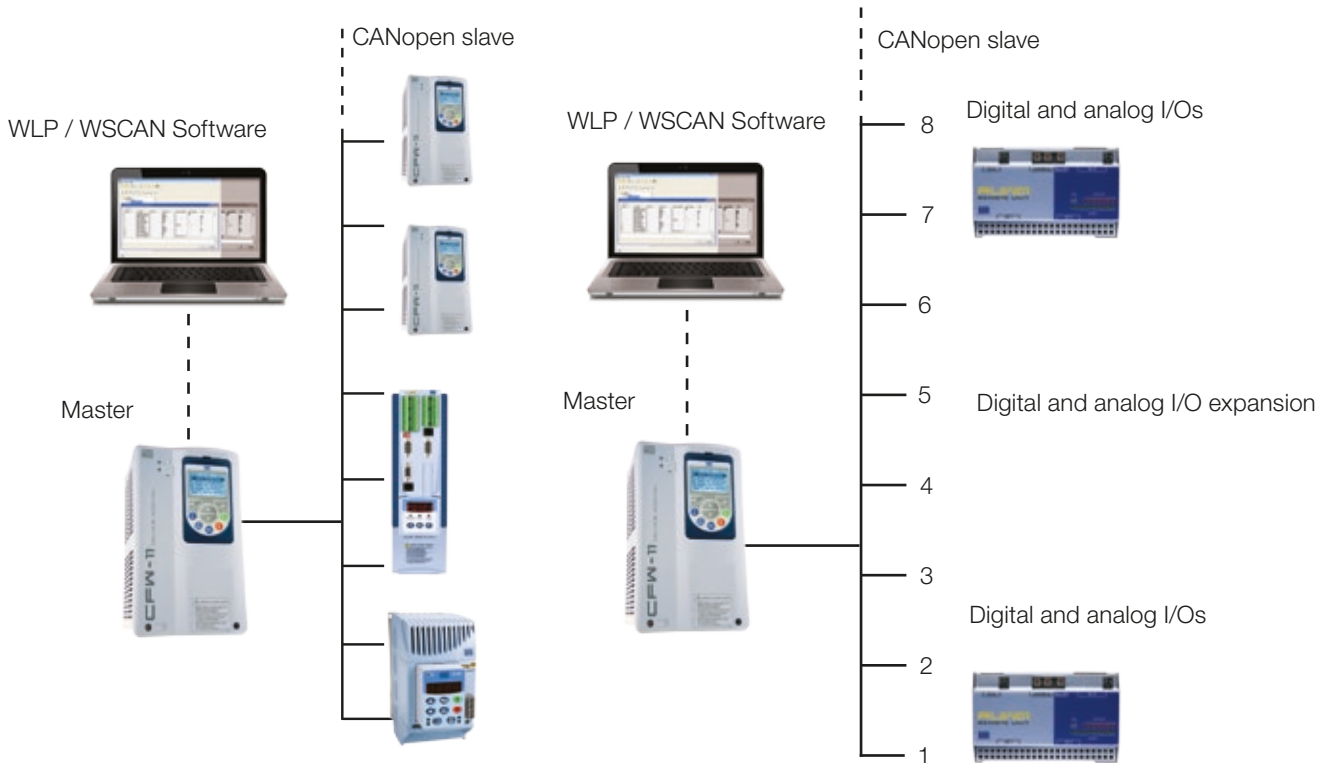

Flash Memory Module

- It stores CFW11 parameters. It ensures that the programming will not be lost as there is a backup of the parameters
- It permits the transfer of parameters stored in the flash memory module to the CFW11 and vice versa. It is an useful function for machine manufactures or in processes where parameter settings are repeated (copy function)
- It stores the applicative software generated by the SoftPLC function

The flash memory module comes as standard on CFW11 series.



USB Connection

Trace Function

Trace function is used to register CFW11 variables (like current, voltage, speed, etc.) when a given event occurs in the system (eg.: alarm / fault, overload, overvoltage, etc.). When a given event takes place, the trigger function activates data storage process. The stored variables can be visualized in the form of graphs by using the SuperDrive G2 software. Trace function simulates a 4-channel oscilloscope. It is a very powerful tool to be used on start-up procedures of systems and on faults diagnosis.

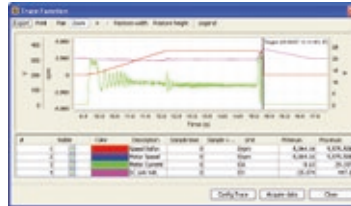

Example of graph visualization screen

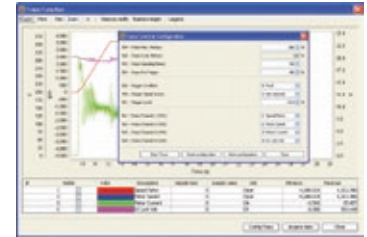

Trace function configuration in the SuperDrive G2

SoftPLC Function

It is a resource that provides PLC features to the CFW11 without the addition of any accessories. It provides flexibility to the product, allowing the user to create his/her own applicative software (user's program).

The SoftPLC main features are:

- Ladder language programming using WLP software
- Access to all VSD parameters and I/Os
- Configurable PLC, mathematical and control blocks
- Applicative software download, upload and online monitoring via USB connection
- Storage of user application in the CFW11 flash memory module (see below)
- Memory capacity of 15 kB for user application storage



Simple and practical programming environment

- User parameters can be individually programmed, allowing tags, units, minimum and maximum values, number of decimal digits and many other characteristics.

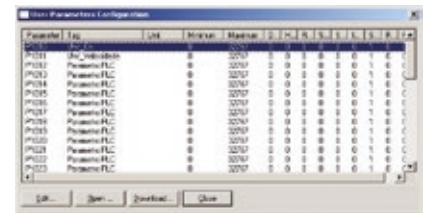

SuperDrive G2

It is a Windows-based software for CFW11 programming, control and monitoring.

The following features are available in the software:

- Automatic CFW11 identification
- Monitoring of CFW11 parameters
- Online parameter changing in the CFW11
- Offline parameter changing in the PC
- Application documents creation
- Trace function (see above)
- Upload of SoftPLC applicative software in the CFW11 flash memory (see page 15)
- Online troubleshooting



This software is available, free of charge, at www.weg.net



Monitoring and parameterization of the parameter list. Comparison to factory default is easy



Integrated environment

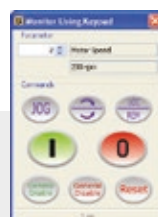

Monitoring and command window using virtual keypad. Start/Stop function, JOG, local / remote, Reverse and reset



Parameter setting

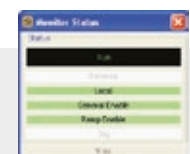

Status monitoring

Coding



■ 1 - Market identification

It defines the language of the manual and the factory parameterization

BR = Brazil
 NA = North America
 MS = Mercosul
 EU = Europe
 SA = South Africa

■ 2 - Line

CFW11 = WEG Variable Speed Drive Series CFW11

■ 3 - Rated Output current for normal overload system

Supply	Single-phase (S)	Single-phase or Three-phase (B)	Three-phase (T)						
	200-240 V ac (2)	200-240 V ac (2)	200-240 V ac (2)	380-480 V ac (4)		500-600 V ac (5)		660-690 V ac (6)	
Current	0006 = 6 A 0007 = 7 A 0010 = 10 A	0006 = 6 A 0007 = 7 A	0007 = 7 A 0010 = 10 A 0013 = 13 A 0016 = 16 A 0024 = 24 A 0028 = 28 A 0033 = 33 A 0045 = 45 A 0054 = 54 A 0070 = 70 A 0086 = 86 A 0105 = 105 A 0142 = 142 A 0180 = 180 A 0211 = 211 A	0003 = 3 A 0005 = 5 A 0007 = 7 A 0010 = 10 A 0013 = 13 A 0017 = 17 A 0024 = 24 A 0031 = 31 A 0038 = 38 A 0045 = 45 A 0058 = 58 A 0070 = 70 A 0088 = 88 A 0105 = 105 A 0142 = 142 A	0180 = 180 A 0211 = 211 A 0242 = 242 A 0312 = 312 A 0370 = 370 A 0477 = 477 A 0515 = 515 A 0601 = 601 A 0720 = 720 A 0795 = 795 A 0877 = 877 A 1062 = 1062 A 1141 = 1141 A	0002 = 2.9 A 0004 = 4.2 A 0007 = 7 A 0010 = 10 A 0012 = 12 A 0017 = 17 A 0022 = 22 A 0027 = 27 A 0032 = 32 A 0044 = 44 A 0053 = 53 A 0063 = 63 A 0080 = 80 A	0107 = 107 A 0125 = 125 A 0150 = 150 A 0170 = 170 A 0216 = 216 A 0289 = 289 A 0315 = 315 A 0365 = 365 A 0435 = 435 A 0584 = 584 A 0625 = 625 A 0758 = 758 A 0804 = 804 A	0002 = 2.9 A 0004 = 4.2 A 0007 = 7 A 0010 = 8.5 A 0012 = 11 A 0017 = 15 A 0022 = 20 A 0027 = 24 A 0032 = 30 A 0044 = 35 A 0053 = 46 A 0063 = 54 A 0080 = 73 A	0107 = 100 A 0125 = 108 A 0150 = 130 A 0170 = 147 A 0216 = 195 A 0289 = 259 A 0315 = 259 A 0365 = 312 A 0435 = 365 A 0584 = 478 A 0625 = 518 A 0758 = 628 A 0804 = 703 A

■ 4 - Number of phases

S = Single-phase
 B = Single-phase or three-phase
 T = Three-phase

■ 5 - Voltage

2 = 200-240 V
 4 = 380-480 V
 5 = 500-600 V
 6 = 660-690 V

■ 6 - Optional accessories

S = factory model
 O = product with optional accessories

■ 7 - Protection degree

Blank = factory model
 N1 = NEMA 1
 21 = IP21
 54 = IP54

■ 8 - Keypad

Blank = factory standard
 IC = without interface (blind cover)

■ 9 - Braking

Blank = factory model
 DB = with built-in IGBT braking (chopper)
 NB = without built-in IGBT braking (chopper)

■ 10 - RFI filter

Blank = factory model
 FA = with built-in RFI filter
 NF = without built-in RFI filter

■ 11 - Safety stop

Blank = factory model
 Y = with Safety Stop function (STO)

■ 12 - External electronic supply 24 V dc

Blank = factory model
 W = with external electronic power supply 24 V dc

■ 13 - Special hardware

Blank = factory model
 H1 = special hardware
 DC = common / DC Bus Version (without rectifier bridge)

■ 14 - Special software

Blank = factory model
 S1 = special software

■ 15 - End of code indicator digit

Z = end of code indicator

Sizing the Drive

The correct way to select a VSD is matching its output current with the motor rated current. However, the following tables present the expected motor power for each VSD model.

Use the motor power ratings following only as a guidance. Motor rated currents may vary with speed and manufacturer. IEC motor powers are based on WEG 4-poles motors, NEMA motor powers are based on NEC table 430-150.

CFW11 - Standard

Motor Voltages Between 220 V ac and 230 V ac

Power supply	Model	Size	Normal duty (ND)	IEC		NEMA		Heavy duty (HD)	IEC		NEMA	
				50 Hz 220 V ac	60 Hz 230 V ac	60 Hz 230 V ac	60 Hz 230 V ac		50 Hz 220 V ac	60 Hz 230 V ac		
			A	kW	HP	A	kW	HP		kW	HP	
200-240 V ac	10	A	CFW11 0006 S2	6	1.1	1.5	5	1.1	1			
			CFW11 0007 S2	7	1.5	2	7	1.5	2			
			CFW11 0010 S2	10	2.2	3	10	2.2	3			
	1/30	A	CFW11 0006 B2	6	1.1	1.5	5	1.1	1			
			CFW11 0007 B2	7	1.5	2	7	1.5	2			
			CFW11 0007 T2	7	1.5	2	5.5	1.1	1			
	30	A	CFW11 0010 T2	10	2.2	3	8	1.5	2			
			CFW11 0013 T2	13	3	3	11	2.2	3			
			CFW11 0016 T2	16	4	5	13	3	3			
			CFW11 0024 T2	24	5.5	7.5	20	5.5	5			
			CFW11 0028 T2	28	7.5	10	24	5.5	7.5			
			CFW11 0033 T2	33.5	9.2	10	28	7.5	10			
			CFW11 0045 T2	45	11	15	36	9.2	10			
			CFW11 0054 T2	54	15	20	45	11	15			
			CFW11 0070 T2	70	18.5	25	56	15	20			
			CFW11 0086 T2	86	22	30	70	18.5	25			
220-230 V ac	30	E	CFW11 0105 T2	105	30	40	86	22	30			
			CFW11 0142 T2	142	37	50	115	30	40			
			CFW11 0180 T2	180	55	60	142	37	50			
			CFW11 0211 T2	211	55	75	180	55	60			

Motor Voltages Between 380 V ac and 480 V ac

Power supply	Model	Size	Normal duty (ND)	IEC		NEMA		Heavy duty (HD)	IEC		NEMA		
				50 Hz 400 V ac	60 Hz 440 V ac	60 Hz 460 V ac	60 Hz 460 V ac		50 Hz 400 V ac	60 Hz 440 V ac	60 Hz 460 V ac		
			A	kW	HP	HP	A	kW	HP	HP			
380-480 V ac	30	A	CFW11 0003 T4	3.6	1.5	2	2	3.6	1.5	2	2		
			CFW11 0005 T4	5	2.2	3	3	5	2.2	3	3		
			CFW11 0007 T4	7	3	4	3	5.5	2.2	3	3		
			CFW11 0010 T4	10	4	7.5	5	10	4	7.5	5		
			CFW11 0013 T4	13.5	5.5	10	7.5	11	5.5	7.5	7.5		
		B	CFW11 0017 T4	17	7.5	12.5	10	13.5	5.5	10	7.5		
			CFW11 0024 T4	24	11	15	15	19	9.2	12.5	10		
			CFW11 0031 T4	31	15	20	20	25	11	15	15		
		C	CFW11 0038 T4	38	18.5	30	25	33	15	25	20		
			CFW11 0045 T4	45	22	30	30	38	18.5	30	25		
			CFW11 0058 T4	58.5	30	40	40	47	22	30	30		
		D	CFW11 0070 T4	70.5	37	50	50	61	30	50	40		
			CFW11 0088 T4	88	45	75	60	73	37	60	50		
		E	CFW11 0105 T4	105	55	75	75	88	45	75	60		
			CFW11 0142 T4	142	75	100	100	115	55	75	75		
			CFW11 0180 T4	180	90	150	150	142	75	100	100		
		F	CFW11 0211 T4	211	110	175	150	180	90	150	150		
			CFW11 0242 T4	242	132	200	200	211	110	150	150		
			CFW11 0312 T4	312	160	250	250	242	132	200	200		
			CFW11 0370 T4	370	200	300	300	312	160	250	250		
			CFW11 0477 T4	477	250	400	400	370	200	300	300		
			CFW11 0515 T4	515	280	400	450	477	250	400	400		
			CFW11 0601 T4	601	315	500	500	515	280	400	450		
			CFW11 0720 T4	720	370	600	600	560	300	450	450		
			CFW11 0795 T4	795	450	680	700	637	355	550	500		
			CFW11 0877 T4	877	500	750	700	715	400	610	600		
H	CFW11 1062 T4	1,062	560	850	900	855	450	680	700				
	CFW11 1141 T4	1,141	630	970	1,000	943	500	750	800				

CFW11 - Standard

Motor Voltages Between 500 V ac and 600 V ac

Power supply	Model	Size	Normal duty (ND)	IEC		NEMA	Heavy duty (HD)	IEC		NEMA	
				50 Hz 525 V ac	50 Hz 575 V ac	60 Hz 575 V ac		50 Hz 525 V ac	50 Hz 575 V ac	60 Hz 575 V ac	
			A	kW	kW	HP	A	kW	kW	HP	
500-600 V ac	3Ø	B	CFW11 0002 T5	2.9	1.5	1.5	2	2.7	1.5	1.5	2
			CFW11 0004 T5	4.2	2.2	2.2	3	3.8	2.2	2.2	3
			CFW11 0007 T5	7.0	4	4	5	6.5	4	4	5
			CFW11 0010 T5	10	5.5	5.5	7.5	9.0	5.5	5.5	7.5
			CFW11 0012 T5	12	7.5	7.5	10	10	5.5	7.5	10
			CFW11 0017 T5	17	11	11	15	17	11	11	15
		C	CFW11 0022 T5	22	15	15	20	19	11	11	15
			CFW11 0027 T5	27	18.5	18.5	25	22	15	15	20
			CFW11 0032 T5	32	22	22	30	27	18.5	18.5	25
			CFW11 0044 T5	44	30	30	40	36	22	22	30
		E	CFW11 0053 T6	53	37	37	50	44	30	30	40
			CFW11 0063 T6	63	45	45	60	53	37	37	50
			CFW11 0080 T6	80	55	55	75	66	45	45	60
			CFW11 0107 T6	107	75	75	100	90	55	55	75
		F	CFW11 0125 T6	125	90	90	125	107	75	75	100
			CFW11 0150 T6	150	110	110	150	122	90	90	125
		G	CFW11 0170 T6	170	110	132	150	150	110	110	150
			CFW11 0216 T6	216	160	160	200	180	132	132	200
			CFW11 0289 T6	289	200	220	300	240	160	185	250
		H	CFW11 0315 T6	315	220	250	300	289	200	220	300
CFW11 0365 T6	365		250	280	350	315	220	250	300		
CFW11 0435 T6	435		315	315	450	357	250	280	350		
H	CFW11 0584 T6	584	450	450	600	504	370	400	500		
	CFW11 0625 T6	625	450	500	700	540	400	450	600		
	CFW11 0758 T6	758	560	560	800	614	450	500	700		
	CFW11 0804 T6	804	560	630	900	682	500	560	700		

Motor Voltages Between 660 V ac and 690 V ac

Power supply	Model	Size	Normal duty (ND)	IEC		NEMA	Heavy duty (HD)	IEC		NEMA	
				50 Hz 660 V ac	50 Hz 690 V ac	60 Hz 660 V ac		50 Hz 660 V ac	50 Hz 690 V ac	60 Hz 660 V ac	
			A	kW	kW	HP	A	kW	kW	HP	
660-690 V ac	3Ø	D	CFW11 0002 T6	2.9	2.2	2.2	3	2.7	1.5	1.5	2
			CFW11 0004 T6	4.2	3	3	4	3.8	2.2	3	4
			CFW11 0007 T6	7.0	5.5	5.5	7.5	6.5	4	5.5	6
			CFW11 0010 T6	8.5	5.5	7.5	10	7.0	5.5	5.5	7.5
			CFW11 0012 T6	11	9.2	9.2	12.5	9.0	7.5	7.5	10
			CFW11 0017 T6	15	11	11	15	13	11	11	15
			CFW11 0022 T6	20	15	15	20	17	15	15	15
			CFW11 0027 T6	24	18.5	22	25	20	15	15	20
		E	CFW11 0032 T6	30	22	22	30	24	18.5	22	25
			CFW11 0044 T6	35	30	30	40	30	22	22	30
			CFW11 0053 T6	46	37	37	50	39	30	37	40
			CFW11 0063 T6	54	45	45	60	46	37	37	50
		F	CFW11 0080 T6	73	55	55	75	61	55	55	75
			CFW11 0107 T6	100	90	90	125	85	75	75	100
			CFW11 0125 T6	108	90	90	125	95	75	90	100
			CFW11 0150 T6	130	110	110	125	108	90	90	125
		G	CFW11 0170 T6	147	132	132	175	127	110	110	150
			CFW11 0216 T6	195	185	185	200	165	132	160	200
			CFW11 0289 T6	225	200	200	250	195	185	185	200
		H	CFW11 0315 T6	259	220	250	300	225	200	220	270
CFW11 0365 T6	312		280	300	350	259	220	250	300		
CFW11 0435 T6	365		315	355	450	312	280	300	350		
H	CFW11 0584 T6	478	450	450	600	410	370	400	500		
	CFW11 0625 T6	518	500	500	650	447	400	450	550		
	CFW11 0758 T6	628	560	560	800	518	500	500	650		
	CFW11 0804 T6	703	630	630	900	597	560	560	750		

CFW11 - IP55 / NEMA12

The CFW11 features an enclosure that protects the drive from splashing water, corrosion and dust. Improved cooling system ensure perfect functionality when operating at maximum loading capacity. Its design is suitable for wall mounting with no need for customized panels and adding the protection against exposure to ultraviolet radiation allows to severe environments exposure.

- Chemical Industry
- Petrochemical Industry
- Food Industry

Same plug-ins for communication protocols, I/Os and temperature controllers can be applied on. Also, as an optional, a built-in disconnect switch can be included.



Motor Voltages 220 V ac / 240 V ac

Power supply	Model	Size	Normal duty (ND)	IEC		Heavy duty (HD)	NEMA		
				50 Hz 220 V ac 230 V ac	60 Hz 230 V ac		50 Hz 220 V ac 230 V ac	60 Hz 230 V ac	
			A	kW	HP	A	kW	HP	
200-240 V ac	30	CFW11 0024 T2 ON12	B	24	5.5	7.5	20	4.5	6
		CFW11 0028 T2 ON12	B	28	7.5	10	24	5.5	7.5
		CFW11 0033 T2 ON12	B	33.5	9.2	12.5	28	7.5	10
		CFW11 0045 T2 ON12	C	45	11	15	36	9.2	12.5
		CFW11 0054 T2 ON12	C	54	15	20	45	11	15
		CFW11 0070 T2 ON12	C	70	18.5	25	56	15	20
		CFW11 0086 T2 ON12	D	86	22	30	70	22	25
200-230 V ac		CFW11 0105 T2 ON12	D	105	30	40	86	22	30
		CFW11 0142 T2 ON12	E	142	37	50	115	37	40
		CFW11 0180 T2 ON12	E	180	45	60	142	45	50
		CFW11 0211 T2 ON12	E	211	55	75	180	55	75

Motor Voltages 380 V ac / 480 V ac

Power supply	Model	Size	Normal duty (ND)	IEC		Heavy duty (HD)	NEMA		
				50 Hz 220 V ac 230 V ac	60 Hz 230 V ac		50 Hz 220 V ac 230 V ac	60 Hz 230 V ac	
			A	kW	HP	A	kW	HP	
380-480 Vac	30	CFW11 0017 T4 ON12	B	17	7.5	10	13.5	5.5	7.5
		CFW11 0024 T4 ON12	B	24	11	15	19	7.5	10
		CFW11 0031 T4 ON12	B	31	15	20	25	11	15
		CFW11 0038 T4 ON12	C	38	18.5	25	33	15	20
		CFW11 0045 T4 ON12	C	45	22	30	38	18.5	25
		CFW11 0058 T4 ON12	C	58.5	30	40	47	22	30
		CFW11 0070 T4 ON12	D	70.5	37	50	61	30	40
		CFW11 0088 T4 ON12	D	88	45	60	73	37	50
		CFW11 0105 T4 ON12	E	105	55	75	88	45	60
		CFW11 0142 T4 ON12	E	142	75	100	115	55	75
		CFW11 0180 T4 ON12	E	180	110	150	142	75	100
		CFW11 0211 T4 ON12	E	211	132	175	180	110	150



Dimensions and Weight

Standard Version

Size	Standard version					
	Dimensions mm (in)			Weight kg (lb)		
	Height (H)	Width (W)	Depth (D)	200-240 V ac	380-480 V ac	500-690 V ac
A	270 (10.61)	145 (5.71)	227 (8.94)	6.3 (13.9)	10 (22.0)	-
B	316 (12.43)	190 (7.48)	227 (8.94)	10.4 (22.9)	10.4 (22.9)	9.1 (20)
C	405 (15.95)	220 (8.67)	293 (11.54)	20.5 (45.2)	20.5 (45.2)	19.6 (43.2)
D	550 (21.63)	300 (11.81)	305 (12.01)	32.6 (71.8)	32.6 (71.8)	34 (75)
E	675 (26.6)	335 (13.2)	358 (14.1)	65 (143.3)	65 (143.3)	64 (141.2)
F	1,234 (48.58)	430 (16.93)	360 (14.17)	-	140 (308.7)	168 (370.5)
G	1,264 (49.76)	535 (21.06)	426 (16.77)	-	215 (474)	258 (569)
H	1,414 (55.67)	626 (27.01)	421 (16.57)	-	220 (485.2)	213 (469.7)



Frame A Frame B Frame C Frame D Frame E Frame F Frame G Frame H

IP55 / NEMA12 Version

Size	Dimensions mm (in)				Weight kg (lb)
	Height (H)	Width (W)	Depth (D)	Depth with DS (D)	
B	529 (20.83)	273 (10.75)	237 (9.33)	279.1 (10.99)	17.0 (37.4)
C	670 (26.38)	307 (12.09)	306 (12.05)	348.1 (13.7)	30.0 (66.1)
D	754 (29.69)	375 (14.76)	301.3 (11.86)	338.6 (13.33)	49.0 (108.02)
E	1000 (39.37)	430 (16.93)	388.8 (15.31)	419 (16.5)	96.0 (211.64)



Mechanical Mounting

Standard Installation



Side by Side Installation



Frame size	Minimum mounting clearance with top cover			
	A mm (in)	B mm (in)	C mm (in)	D mm (in)
A	25 (0.98)	25 (0.98)	10 (0.39)	30 (0.39)
B	40 (1.57)	45 (1.57)	10 (0.39)	30 (0.39)
C	110 (4.33)	130 (5.12)	10 (0.39)	30 (0.39)
D	110 (4.33)	130 (5.12)	10 (0.39)	30 (0.39)
E	150 (5.91)	250 (9.84)	20 (0.78)	80 (3.15)
F, G and H	150 (5.91)	250 (9.84)	20 (0.78)	80 (3.15)

Notes: When one VSD is assembled above another, use the distance A+B and deflect the hot air coming from the VSD. For frame size A, B and C: side by side assembly without lateral spacing and with the removal of the top cover. below.

Mechanical Installation | Panel Assembly

Surface Assembly

Frame size	a2 mm (in)	b2 mm (in)	c2 mm (in)
A	115 (4.53)	250 (9.85)	M5
B	150 (5.91)	300 (11.82)	M5
C	150 (5.91)	375 (14.77)	M6
D	200 (7.88)	525 (20.67)	M8
E	200 (7.88)	650 (25.60)	M8
F	150 (5.91)	1,200 (47.24)	M10
G	200 (7.87)	1,225 (48.23)	M10
H	175 (6.89)	1,350 (53.15)	M10

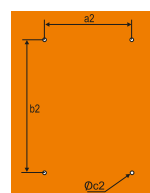

Sizes A up to E

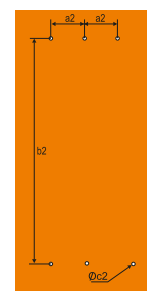

Sizes F, G and H

Flange Assembly (IP54 Rated When Mounting the Heat-Sink Outside the Enclosure)

Frame size	a3 mm (in)	b3 mm (in)	c3 mm (in)	d3 mm (in)	e3 mm (in)
A	130 (5.12)	240 (9.45)	M5	135 (5.32)	225 (8.86)
B	175 (6.84)	285 (11.23)	M5	179 (7.05)	271 (10.65)
C	195 (7.68)	365 (14.38)	M6	205 (8.08)	345 (13.59)
D	275 (10.83)	517 (20.36)	M8	285 (11.23)	485 (19.10)
E	275 (10.83)	635 (25.00)	M8	315 (12.40)	615 (24.21)
F	350 (13.78)	1,185 (46.61)	M10	391 (15.39)	1,146 (45.12)
G	400 (15.75)	1,220 (48.03)	M10	495 (19.49)	1,182 (46.53)
H	595 (23.43)	1,345 (52.95)	M10	647 (25.47)	1,307 (51.46)

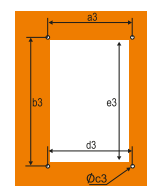

Note: From sizes A to D the inverter area that will be outside the panel has IP54 protection degree, for frame size E, check the User's Manual.

For sizes F, G and H the inverter area that will be outside the panel has IP20 protection degree.

CFW11 - Block Diagram

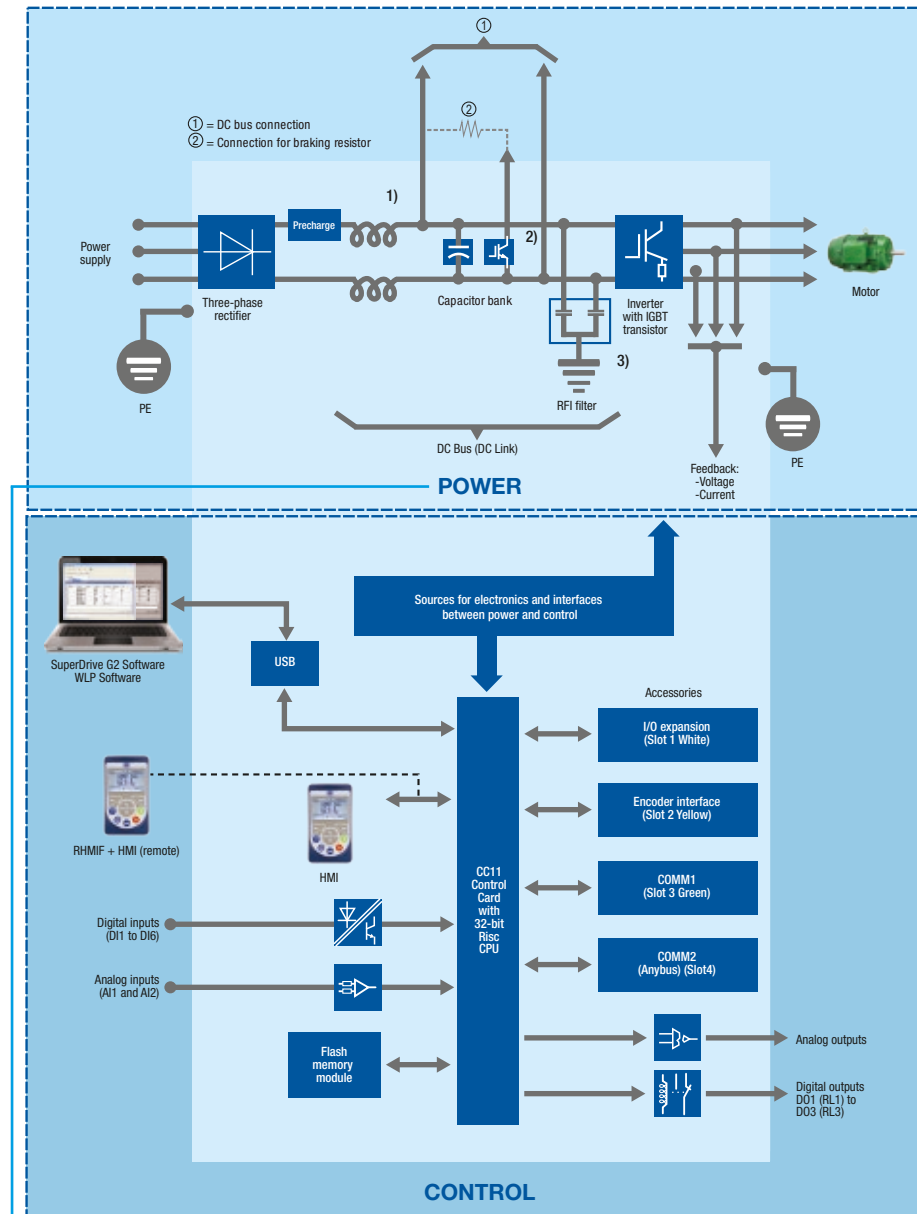

Notes: 1) Available until frame size G.
 2) IGBT braking (chopper).
 3) Standard RFI filter for sizes E, F, G and H.

Please refer to the user manual for more information.

CFW11 Modular Drive

The Modular Drive solution combines high efficiency, easy installation and operation, in a compact design. The CFW11 Modular covers power levels from 350 kW to 2,000 kW (500 to 2,500 HP), rated at 380-480 V ac, 500-600 V ac or 660-690 V ac, with the option for 6, 12-pulses or regenerative (AFE).

The main parts of the Modular Drive are the Rectifier Unit – UR11, the Power Unit – UP11 and Control Unit – UC11.

Rectifier Unit (UR11)

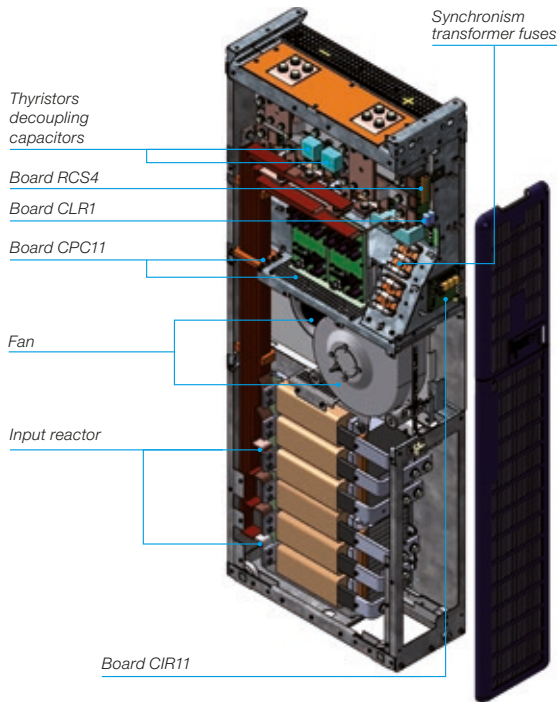

Power Unit (UP11)

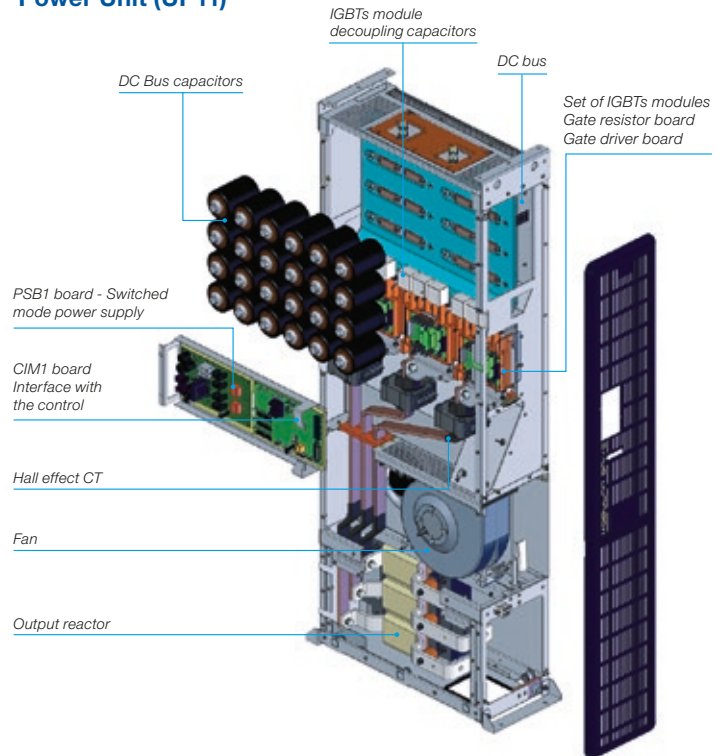

Control Unit (UC11)

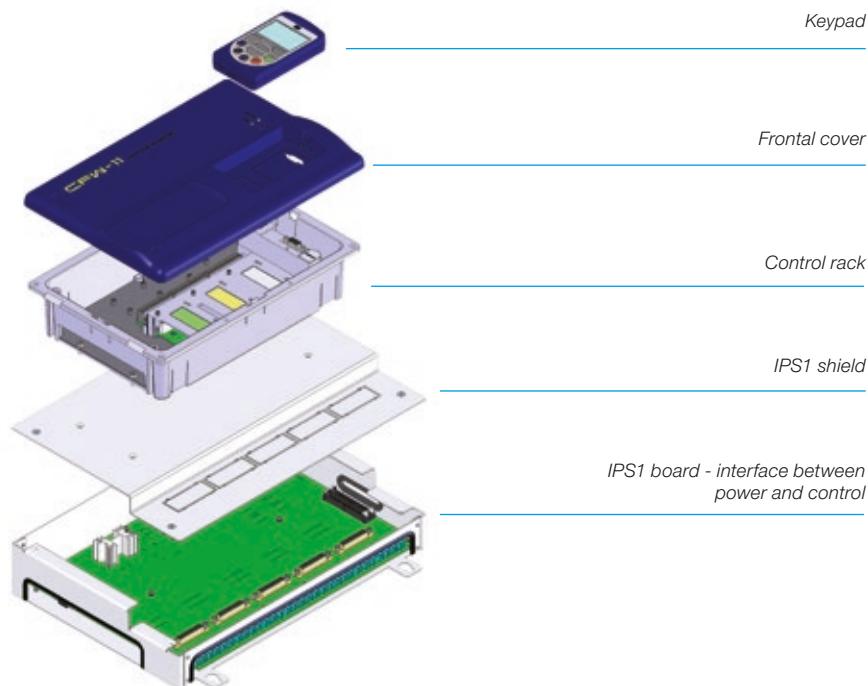

CFW11 Modular – Drive Ratings

Sizing the Drive

The correct way to select a VSD is matching its output current with the motor rated current. However, the tables below present the expected motor power for each VSD model. Use the motor power ratings below only as a guidance. Motor rated currents may vary with speed and manufacturer. IEC motor powers are based on WEG 4-pole motors; NEMA motor powers are based on NEC table 430-150.

Power supply 3φ	Normal Duty (ND)	IEC			Heavy Duty (HD)	NEMA			Drive configuration			
		50 Hz 400 V ac	60 Hz 440 V ac	60 Hz 460 V ac		50 Hz 400 V ac	60 Hz 440 V ac	60 Hz 460 V ac	Rectifier pulse	UR11	UP11-02	UC11
	A	kW	HP	HP	A	kW	HP					
380-480 V ac	600	330	500	500	515	280	400	450	6/12	1	1	1
	1,140	630	950	1,000	979	560	800	800	6/12	1	2	1
	1,710	1,000	1,350	1,500	1,468	800	1,250	1,250	6/12	2	3	1
	2,280	1,250	2,000	2,000	1,957	1,120	1,750	1,750	6/12	2	4	1
	2,850	1,600	2,500	2,500	2,446	1,400	2,000	2,000	6/12	3	5	1

Power supply 3φ	Normal Duty (ND)	IEC			Heavy Duty (HD)	NEMA			Drive configuration			
		50 Hz 525 V ac	60 Hz 575 V ac	60 Hz 575 V ac		50 Hz 525 V ac	60 Hz 575 V ac	60 Hz 575 V ac	Rectifier pulse	UR11	UP11-01	UC11
	A	kW	HP	HP	A	kW	HP					
500-600 V ac	470	315	500	500	380	280	400	400	6/12	1	1	1
	893	630	1,000	1,000	722	500	800	800	6/12	1	2	1
	1,340	1,000	1,350	1,500	1,083	800	1,250	1,100	6/12	2	3	1
	1,786	1,250	1,750	1,750	1,444	1,120	1,500	1,350	6/12	2	4	1
	2,232	1,600	2,500	2,500	1,805	1,400	2,000	2,000	6/12	3	5	1

Power supply 3φ	Normal Duty (ND)	IEC		Heavy Duty (HD)	IEC		Drive configuration			
		50 Hz 660 V ac	60 Hz 690 V ac		50 Hz 660 V ac	60 Hz 660 V ac	Rectifier pulse	UR11	UP11-01	UC11
	A	kW	HP	A	kW	HP				
660-690 V ac	427	400	550	340	315	400	6/12	1	1	1
	811	710	1,000	646	560	800	6/12	1	2	1
	1,217	1,120	1,500	969	900	1,250	6/12	2	3	1
	1,622	1,600	2,000	1,292	1,250	1,750	6/12	2	4	1
	2,028	2,000	2,500	1,615	1,400	2,000	6/12	3	5	1



Example of CFW11 Modular Drive Configuration

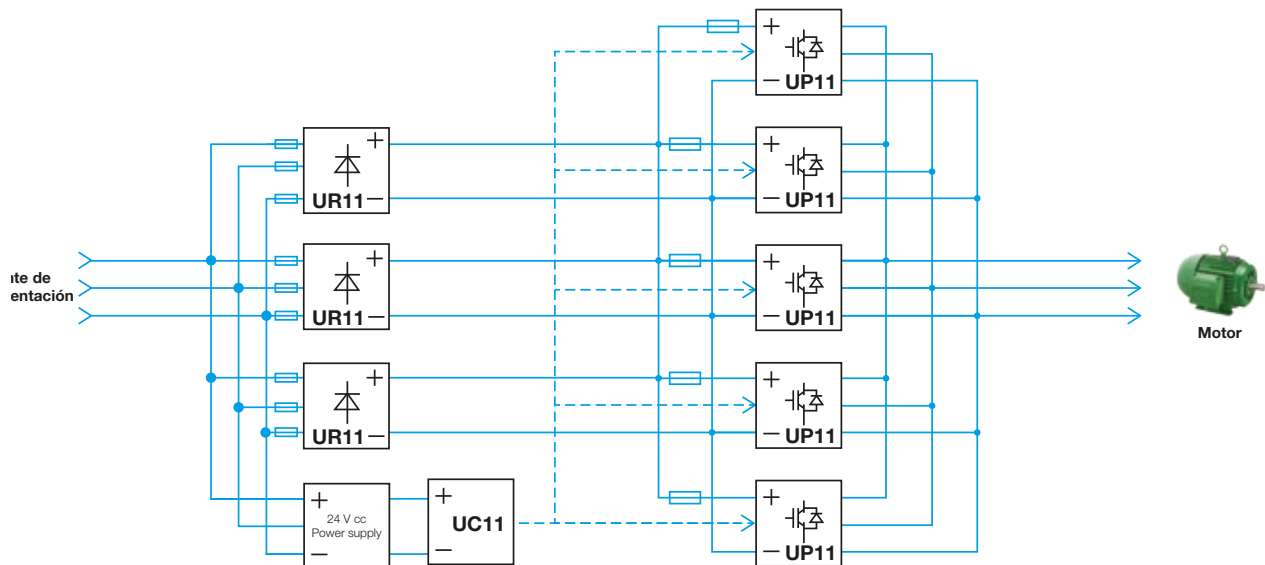

Note: 1) Additional items are needed for the complete panel assembly, such as: AC fuses, DC link fuses, circuit breaker or disconnect switch at the input, 24 V dc power supply and, in the case of 12-pulse configuration, it is also necessary to have a phase shifting transformer.

Technical Data

Power supply and power range		
Voltage and power range	Single phase	220-240 V ac (+10%, -15%) (1.5 to 3 HP) 1.1 to 2.2 kW
	Three phases	220-240 V ac (+10%, -15%) (1.5 to 75 HP) 1.1 to 55 kW
		380-480 V ac (+10%, -15%) (2 to 1,000 HP) 1.5 to 750 kW
		500-600 V ac (+10%, -15%) (2 to 900 HP) 1.5 to 630 kW
		660-690 V ac (+10%, -15%) (3 to 900 HP) 1.5 to 630 kW
Frequency	50/60 Hz (+/-2%: 48 a 63 Hz)	
Displacement factor	Greater than 0.98	
Efficiency	Greater than 0.97	

Inverter output		
Voltage range	Three phase, 0 up to power supply voltage	
Frequency range	0 to 3.4x motor rated frequency ¹⁾	
Switching frequency	Standard: 5 kHz (frame sizes A, B, C, D); 2.5 kHz (frame size E); 2 kHz (frame size F, G and H) Options available 2.5 / 5 / 10 kHz	
Overload	Normal duty cycle	110% for 1min every 10min
		150% for 3s every 10min
	Heavy duty cycle	150% for 1min every 10min
		200% for 3s every 10min
Time (ramps)	Acceleration	0 to 999s
	Deceleration	0 to 999s

Environment		
Operation temperature	220-240 V ac 380-480 V ac	-10 °C to 50 °C (frame sizes A, B, C, D) -10 °C to 45 °C (frame sizes E, F and G)
	500-600 V ac 660-690 V ac	-10 °C to 50 °C (frame sizes B and D) -10 °C to 45 °C (frame sizes E, F and G) -10 °C to 40 °C (frame sizes H)
	IP55/NEMA12	-10 °C a 40 °C
	Up to 60 °C with current derating for frame sizes A, B, C, D and the IP55/NEMA12 version	
	Up to 55 °C with current derating for frame size E, F, G and H (For frame size H, between 40 °C and 45 °C the derating is 1%)	
Humidity	5 to 90% without condensation	
Altitude	0 to 1,000 meters Up to 4,000 meters with current reduction (1% for every 100 meters above 1,000 meters)	

Protection degree	
IP21	Standard for frame sizes A, B, C. For frame size D the top cover kit has to be added. Frame Sizes E, F, G and H option not available
IP20	Standard for frame sizes D, E, F, G and H. Frame sizes A, B and C the top cover has to be removed
NEMA1	Standard for frame size D Optional for frame sizes A, B, C, E, F and G
IP55/NEMA12	Frame size B, C, D y E

Braking methods	
Rheostatic braking (chopper)	Supply available built-in or with external module (DBW03) External braking resistor (not provided)
Optimal braking	Does not need braking resistor
DC braking	Direct current applied to the motor

Performance		
Speed control	V/F	Regulation: 1% of rated speed Speed variation range: 1:20
	Voltage vector (VVV)	Regulation: 1% of rated speed Speed variation range: 1:30
	Sensorless vector	Regulation: 0.5% of rated speed Speed variation range: 1:100
	Vector with encoder (with accessory ENC-01, ENC-02, PLC11-01 and PLC11-02)	Regulation: ±0.01% of rated speed with 14-bit analog input (10A)
		Regulation: ±0.01% of rated speed with digital reference (keyboard, serial fieldbus, electronic potentiometer, multispeed)
Torque control	Regulation: ±0.05% of rated speed with 12-bit analog input	
	Range: 10 to 180%	
	Regulation: ±5% of rated torque	
Sensorless vector	Range: 20 to 180%	
	Regulation: ±10% of rated torque (above 3 Hz)	

Inputs and outputs (I/Os) in the standard product		
Inputs	Digital	6 isolated inputs, 24 V dc, programmable functions
	Analog	2 differential inputs isolated by differential amplifier, programmable functions
		Resolution: - AI1: 12 bits - AI2: 11 bits + signal
		Signals: 0 to 10 V dc, 0 to 20 mA or 4 to 20 mA
Outputs	Relay	3 relays with NO / NC contacts, 240 V ac / 1A, programmable functions
		2 isolated outputs, programmable functions
	Analog	Resolution: 11 bits
		Load: 0 to 10 V: R _L ≥ 10 kΩ 0 to 20 mA or 4 to 20 mA: R _L < 500Ω
Available supply to user	24 V dc + -20%, 500 mA	

Note: 1) This maximum value can change according to the used control mode and switching frequency. The maximum permissible speed is 18,000 rpm.

Technical Data

Communication	
Profibus-DP	Profibus-DP-01 (slot 3) PROFDP-05 (slot 4)
DeviceNet	CAN/RS485-01 (slot 3)
	CAN-01 (slot 3)
	DeviceNet-05 (slot 4)
CANopen	CAN/RS485-01 (slot 3)
	CAN-01 (slot 3)
CANopen Master/Slave	PLC11-01 1, 2 and 3
Ethernet / IP	ETHERNET/IP-05 (slot 4)
Modbus-TCP	Modbus-TCP-05 (slot 4)
Profinet IO	PROFINETIO-05 (slot 4)
Modbus-RTU (RS485)	RS485-01 (slot 3)
	CAN/RS485-01 (slot 3)
	RS485-05 (slot 4)
Modbus-RTU (RS232)	RS232-01 and RS232-02 (slot 3)
	RS232-05 (slot 4)
USB	Built into the standard product
	Communication with SuperDrive G2 software
	Communication with WLP Software used for programming and monitoring the SoftPLC function and the PLC11 accessories

Safety standards
UL 508C Power conversion equipment
UL 840 Insulation coordination including clearances and creepage distances for electrical equipment
EN 61800-5-1 Safety requirements electrical, thermal and energy
EN 50178 Electronic equipment for use in power installations
EN 60204-1 Safety of machinery. Electrical equipment of machines. Part 1: General requirements. Note: in order to have a machine in conformity with this norm, the machine manufacturer is responsible for the installation of an emergency shutdown device and an equipment for network sectioning
EN 60146 (IEC 146) Semiconductor converters
EN 61800-2 Adjustable speed electrical power drive systems - Part 2: General requirements - rating specifications for low voltage adjustable frequency a.c. power drive systems

Mechanical construction standards
EN 60529 - Degrees of protection provided by enclosures (IP Code)
UL 50 - Enclosures for electrical equipment

Protections
Overcurrent / short circuit
Under / overvoltage in the power circuit
Phase loss
Overtemperature in the VSD (IGBTs, rectifier and internal air in the electronic cards)
Overtemperature in the motor
Overload in the braking resistor
Overload in the IGBTs
Overload in the motor
Fault / external alarm
Fault in the CPU or memory
Phase-to-ground short circuit at the output
Fault in the heatsink fan
Motor overspeed
Incorrect connection of encoder

Electromagnetic compatibility standards (EMC)
EN 61800-3 - Adjustable speed electrical power drive systems Part 3: EMC product standard including specific test methods
EN 55011 - Limits and methods of measurement of radio disturbance characteristics of industrial, scientific and medical (ISM) radio-frequency equipment
CISPR 11 - Industrial, scientific and medical (ISM) radio-frequency equipment Electromagnetic disturbance characteristics Limits and methods of measurement
EN 61000-4-2 - Electromagnetic Compatibility Standards (EMC) Part 4: Testing and measurement techniques - Section 2: Electrostatic discharge immunity test
EN 61000-4-3 - Electromagnetic Compatibility Standards (EMC) Part 4: Testing and measurement techniques - Section 3: Radiated, radiofrequency, electromagnetic field immunity test
EN 61000-4-4 - Electromagnetic Compatibility Standards (EMC) Part 4: Testing and measurement techniques - Section 4: Electrical fast transient / burst immunity test
EN 61000-4-5 - Electromagnetic Compatibility Standards (EMC) Part 4: Testing and measurement techniques - Section 5: Surge immunity test
EN 61000-4-6 - Electromagnetic Compatibility Standards (EMC) Part 4: Testing and measurement techniques - Section 6: Immunity to conducted disturbances, induced by radio-frequency fields

WEG Worldwide Operations

ARGENTINA

San Francisco - Cordoba
Phone: +54 3564 421484
info-ar@weg.net

Cordoba - Cordoba
Phone: +54 351 4641366
weg-morbe@weg.com.ar

Buenos Aires
Phone: +54 11 42998000
ventas@pulverlux.com.ar

AUSTRALIA

Scoresby - Victoria
Phone: +61 3 97654600
info-au@weg.net

AUSTRIA

Markt Piesting - Wiener
Neustadt-Land
Phone: +43 2633 4040
watt@wattdrive.com

BELGIUM

Nivelles - Belgium
Phone: +32 67 888420
info-be@weg.net

BRAZIL

Jaraguá do Sul - Santa Catarina
Phone: +55 47 32764000
info-br@weg.net

CHILE

La Reina - Santiago
Phone: +56 2 27848900
info-cl@weg.net

CHINA

Nantong - Jiangsu
Phone: +86 513 85989333
info-cn@weg.net

Changzhou - Jiangsu
Phone: +86 519 88067692
info-cn@weg.net

COLOMBIA

San Cayetano - Bogota
Phone: +57 1 4160166
info-co@weg.net

ECUADOR

El Batán - Quito
Phone: +593 2 5144339
ceccato@weg.net

FRANCE

Saint-Quentin-Fallavier - Isère
Phone: +33 4 74991135
info-fr@weg.net

GERMANY

Türnich - Kerpen
Phone: +49 2237 92910
info-de@weg.net

Balingen - Baden-Württemberg
Phone: +49 7433 90410
info@weg-antriebe.de

Homburg (Efze) - Hesse
Phone: +49 5681 99520
info@akh-antriebstechnik.de

GHANA

Accra
Phone: +233 30 2766490
info@zestghana.com.gh

INDIA

Bangalore - Karnataka
Phone: +91 80 41282007
info-in@weg.net

Hosur - Tamil Nadu
Phone: +91 4344 301577
info-in@weg.net

ITALY

Cinisello Balsamo - Milano
Phone: +39 2 61293535
info-it@weg.net

JAPAN

Yokohama - Kanagawa
Phone: +81 45 5503030
info-jp@weg.net

MALAYSIA

Shah Alam - Selangor
Phone: +60 3 78591626
info@wattdrive.com.my

MEXICO

Huehuetoca - Mexico
Phone: +52 55 53214275
info-mx@weg.net

Tizayuca - Hidalgo
Phone: +52 77 97963790

NETHERLANDS

Oldenzaal - Overijssel
Phone: +31 541 571080
info-nl@weg.net

PERU

La Victoria - Lima
Phone: +51 1 2097600
info-pe@weg.net

PORTUGAL

Maia - Porto
Phone: +351 22 9477700
info-pt@weg.net

RUSSIA and CIS

Saint Petersburg
Phone: +7 812 363 2172
sales-wes@weg.net

SOUTH AFRICA

Johannesburg
Phone: +27 11 7236000
info@zest.co.za

SPAIN

Coslada - Madrid
Phone: +34 91 6553008
wegiberia@wegiberia.es

SINGAPORE

Singapore
Phone: +65 68589081
info-sg@weg.net

Singapore
Phone: +65 68622220
watteuro@watteuro.com.sg

SCANDINAVIA

Mölnlycke - Sweden
Phone: +46 31 888000
info-se@weg.net

UK

Redditch - Worcestershire
Phone: +44 1527 513800
info-uk@weg.net

UNITED ARAB EMIRATES

Jebel Ali - Dubai
Phone: +971 4 8130800
info-ae@weg.net

USA

Duluth - Georgia
Phone: +1 678 2492000
info-us@weg.net

Minneapolis - Minnesota
Phone: +1 612 3788000

VENEZUELA

Valencia - Carabobo
Phone: +58 241 8210582
info-ve@weg.net

For those countries where there is not a WEG own operation, find our local distributor at www.weg.net.



WEG Group - Automation Business Unit
Jaraguá do Sul - SC - Brazil
Phone: +55 47 3276 4000
automacao@weg.net
www.weg.net

